

- ★ 100% EAS Guaranteed
- ★ Green Device Available
- ★ Super Low Gate Charge
- ★ Excellent CdV/dt effect decline
- ★ Advanced high cell density Trench technology

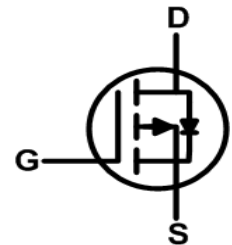
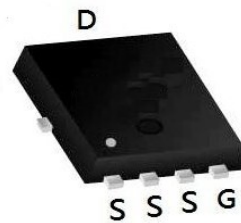

Product Summary

BVDSS	R _{DS(on)}	I _D
100V	12mΩ	50A

Description

The XXWS50N10DF is the high cell density trenched N-ch MOSFETs, which provide excellent R_{DS(on)} and gate charge for most of the synchronous buck converter applications.

The XXWS50N10DF meet the RoHS and Green Product requirement, 100% EAS guaranteed with full function reliability approved.

PDFN5X6 Pin Configuration

Absolute Maximum Ratings (T_A = 25°C, unless otherwise noted)

Parameter		Symbol	Value	Unit
Drain-Source Voltage		V _{DS}	100	V
Gate-Source Voltage		V _{GS}	±20	V
Continuous Drain Current	T _C =25°C	I _D	50	A
	T _C =100°C		29	
Pulsed Drain Current ¹		I _{DM}	184	A
Single Pulse Avalanche Energy ²		EAS	80	mJ
Total Power Dissipation	T _C =25°C	P _D	71.4	W
Operating Junction and Storage Temperature Range		T _J , T _{STG}	-55 to 150	°C

Thermal Characteristics

Parameter	Symbol	Value	Unit
Thermal Resistance from Junction-to-Ambient ³	R _{θJA}	52	°C/W
Thermal Resistance from Junction-to-Lead	R _{θJC}	1.75	°C/W

N-Ch 100V Fast Switching MOSFETs
Electrical Characteristics (T_J = 25°C, unless otherwise noted)

Parameter	Symbol	Test Conditions	Min.	Typ.	Max.	Unit
Static Characteristics						
Drain-Source Breakdown Voltage	V_{(BR)DSS}	V _{GS} = 0V, I _D = 250μA	100	-	-	V
Gate-Body Leakage Current	I_{GSS}	V _{DS} = 0V, V _{GS} = ±20V	-	-	±100	nA
Zero Gate Voltage Drain Current	T _J =25°C	V _{DS} = 100V, V _{GS} = 0V	-	-	1	μA
	T _J =100°C		-	-	100	
Gate-Threshold Voltage	V_{GS(th)}	V _{DS} = V _{GS} , I _D = 250μA	1	1.7	2.5	V
Drain-Source on-Resistance ⁴	R_{DS(on)}	V _{GS} = 10V, I _D = 20A	-	12	17	mΩ
		V _{GS} = 4.5V, I _D = 10A	-	14.5	20	
Forward Transconductance ⁴	g_{fs}	V _{DS} = 10V, I _D = 20A	-	54	-	S
Dynamic Characteristics⁵						
Input Capacitance	C_{iss}	V _{DS} = 50V, V _{GS} = 0V, f = 1MHz	-	1208	-	pF
Output Capacitance	C_{oss}		-	144	-	
Reverse Transfer Capacitance	C_{rss}		-	11.3	-	
Gate Resistance	R_G	f = 1MHz	-	1.8	-	Ω
Switching Characteristics⁵						
Total Gate Charge	Q_g	V _{GS} = 10V, V _{DS} = 50V, I _D = 20A	-	22.7	-	nC
Gate-Source Charge	Q_{gs}		-	3	-	
Gate-Drain Charge	Q_{gd}		-	5	-	
Turn-on Delay Time	t_{d(on)}	V _{GS} = 10V, V _{DD} = 50V, R _G = 3Ω, I _D = 20A	-	9.2	-	ns
Rise Time	t_r		-	3.6	-	
Turn-off Delay Time	t_{d(off)}		-	25.6	-	
Fall Time	t_f		-	4.4	-	
Body Diode Reverse Recovery Time	t_{rr}	I _F = 20A, dI/dt = 100A/μs	-	30	-	ns
Body Diode Reverse Recovery Charge	Q_{rr}		-	42	-	nC
Drain-Source Body Diode Characteristics						
Diode Forward Voltage ⁴	V_{SD}	I _S = 20A, V _{GS} = 0V	-	-	1.2	V
Continuous Source Current	T _C =25°C	I_S	-	-	50	A

1. Repetitive rating, pulse width limited by junction temperature T_{J(MAX)}=150°C

2. The EAS data shows Max. rating . The test condition is V_{DD}=25V, V_{GS}=10V, L=0.1mH, I_{AS}=40A.

3. The data tested by surface mounted on a 1 inch2 FR-4 board with 2OZ copper, The value in any given application depends on the user's specific board design.

4. The data tested by pulsed , pulse width ≤ 300us , duty cycle ≤ 2%.

5. This value is guaranteed by design hence it is not included in the production test.

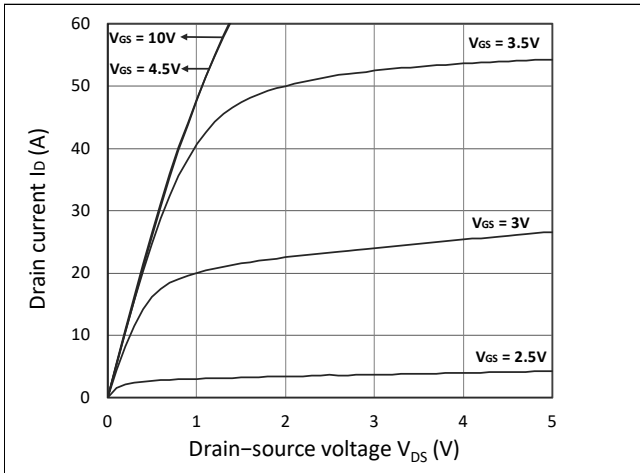
Typical Characteristics


Figure 1. Output Characteristics

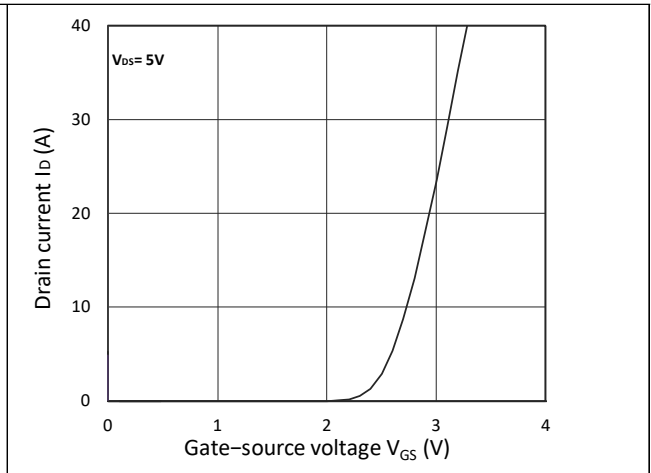


Figure 2. Transfer Characteristics

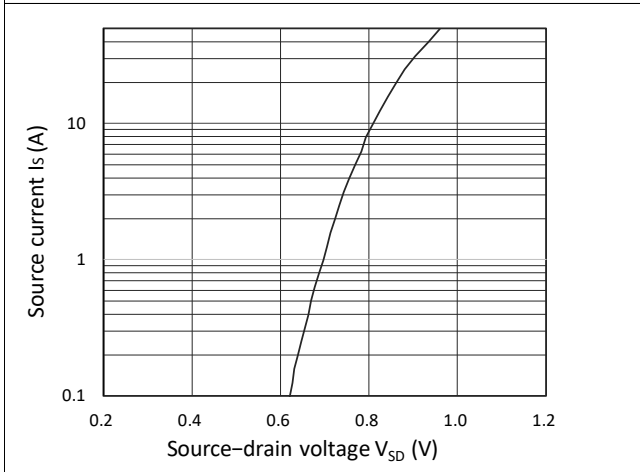
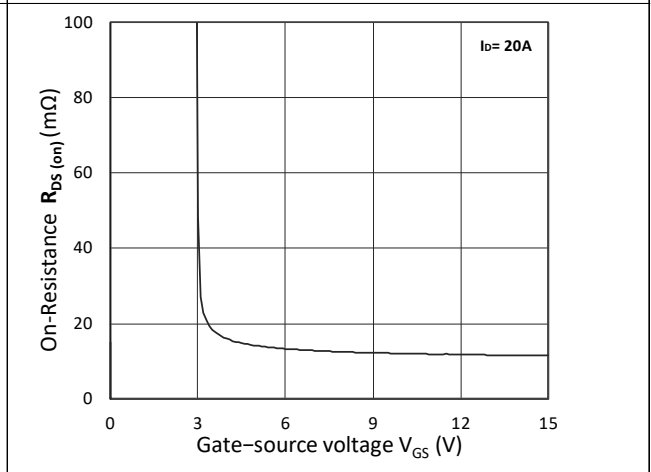
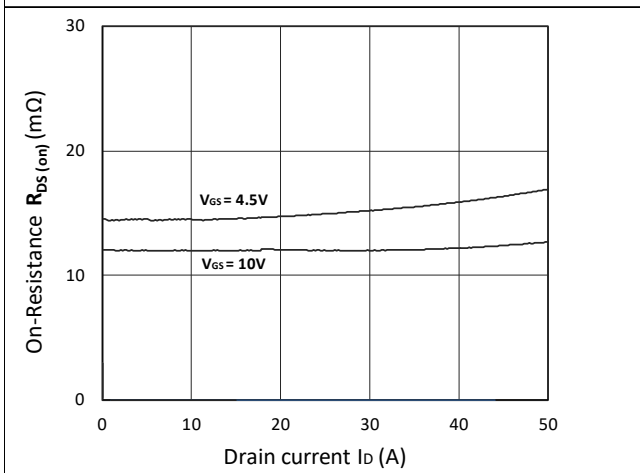
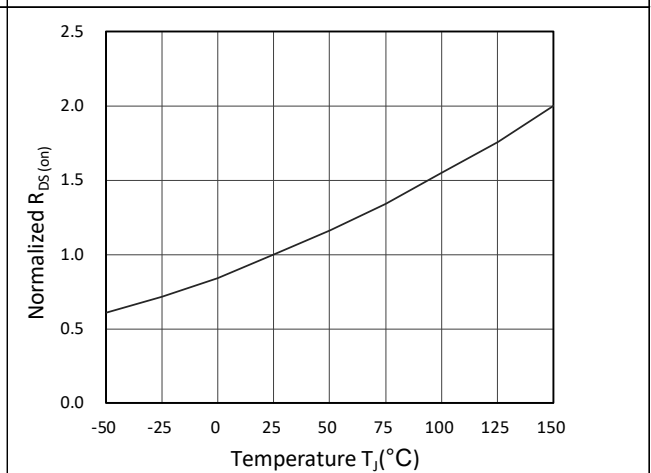


Figure 3. Forward Characteristics of Reverse


 Figure 4. $R_{DS(ON)}$ vs. V_{GS}

 Figure 5. $R_{DS(ON)}$ vs. I_D

 Figure 6. Normalized $R_{DS(ON)}$ vs. Temperature

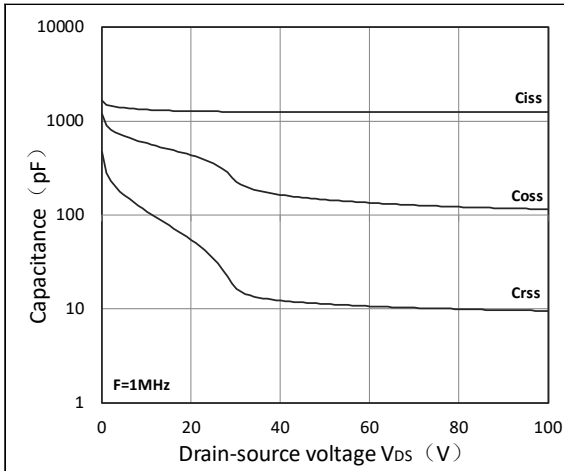


Figure 7. Capacitance Characteristics

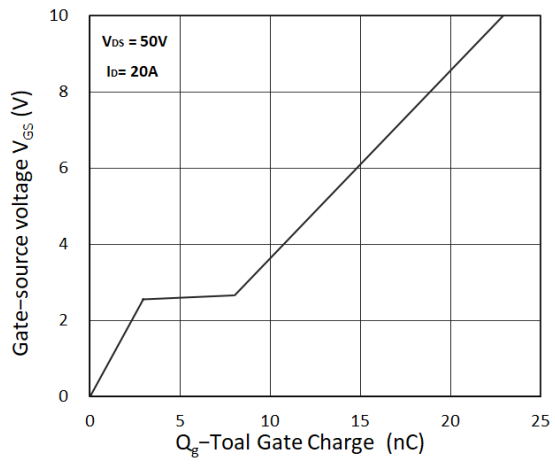


Figure 8. Gate Charge Characteristics

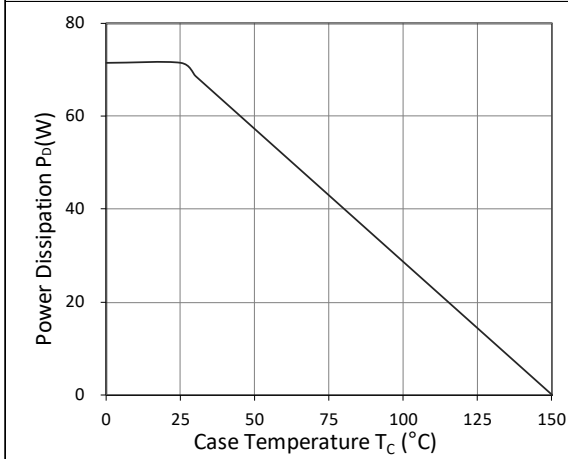


Figure 9. Power Dissipation

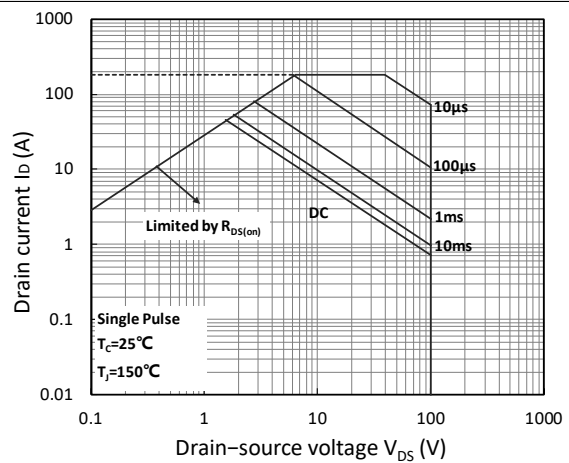


Figure 10. Safe Operating Area

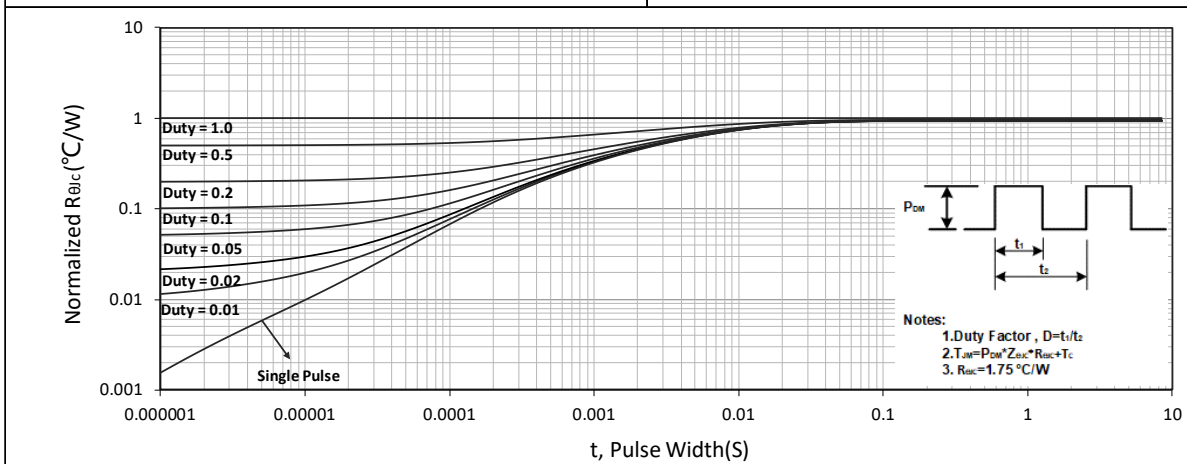


Figure 11. Normalized Maximum Transient Thermal Impedance

Test Circuit

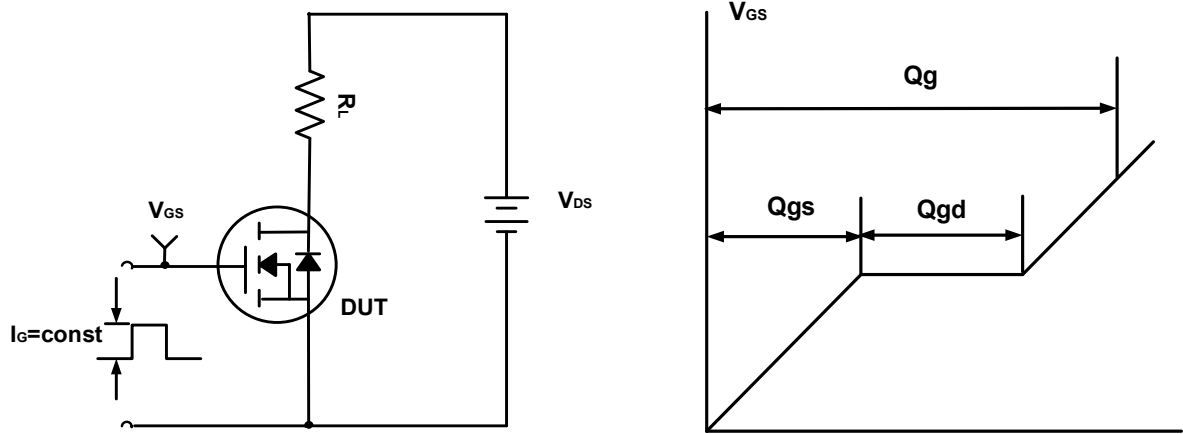


Figure A. Gate Charge Test Circuit & Waveforms

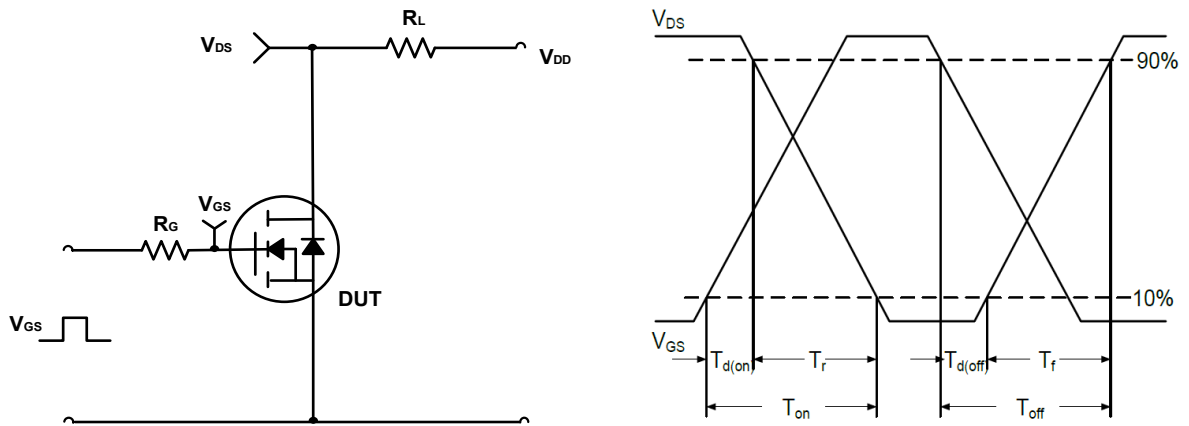


Figure B. Switching Test Circuit & Waveforms

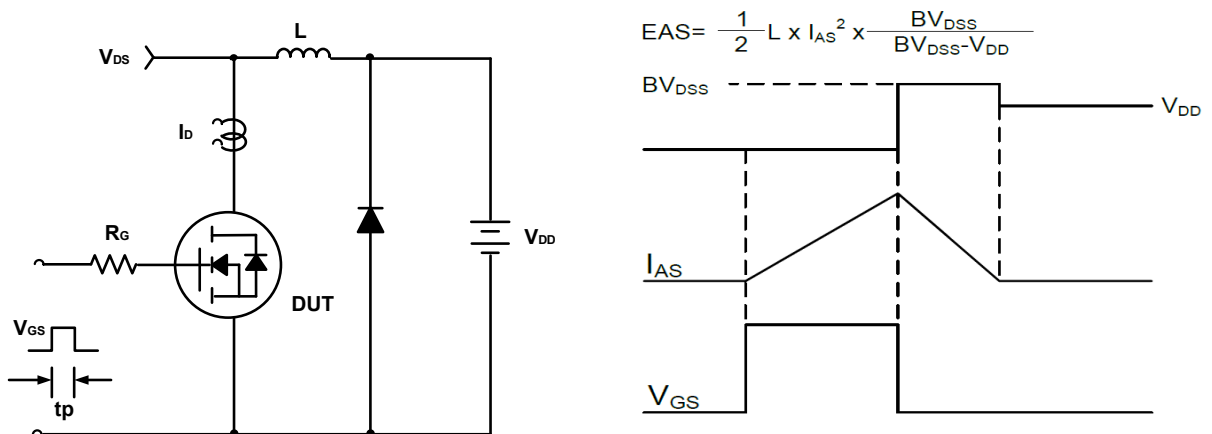
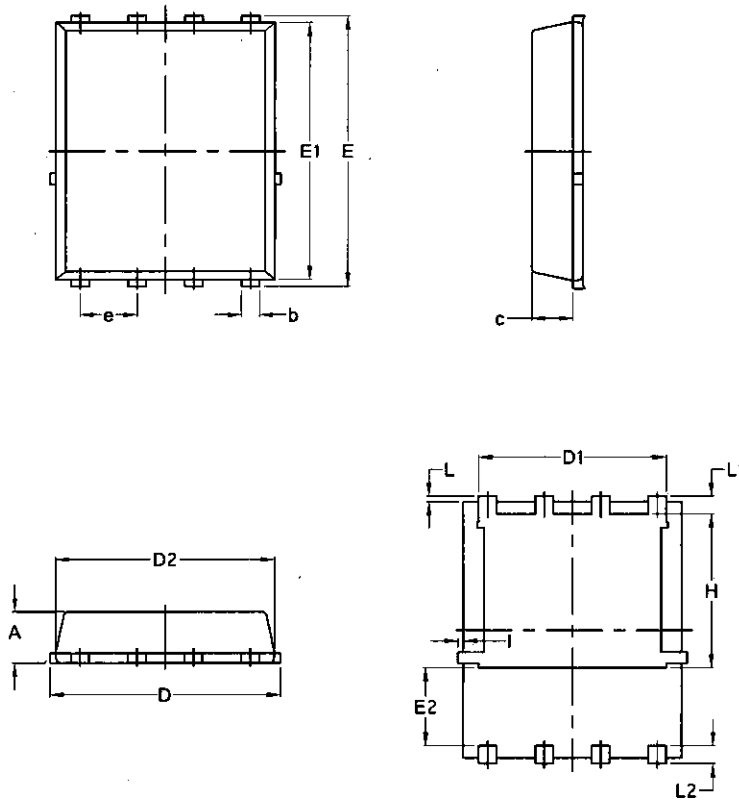


Figure C. Unclamped Inductive Switching Circuit & Waveforms

Package Mechanical Data-DFN5*6-8L-Single


Symbol	Common			
	mm		Inch	
	Min	Max	Min	Max
A	1.03	1.17	0.0406	0.0461
b	0.34	0.48	0.0134	0.0189
c	0.824	0.0970	0.0324	0.082
D	4.80	5.40	0.1890	0.2126
D1	4.11	4.31	0.1618	0.1697
D2	4.80	5.00	0.1890	0.1969
E	5.95	6.15	0.2343	0.2421
E1	5.65	5.85	0.2224	0.2303
E2	1.60	/	0.0630	/
e	1.27 BSC		0.05 BSC	
L	0.05	0.25	0.0020	0.0098
L1	0.38	0.50	0.0150	0.0197
L2	0.38	0.50	0.0150	0.0197
H	3.30	3.50	0.1299	0.1378
I	/	0.18	/	0.0070