



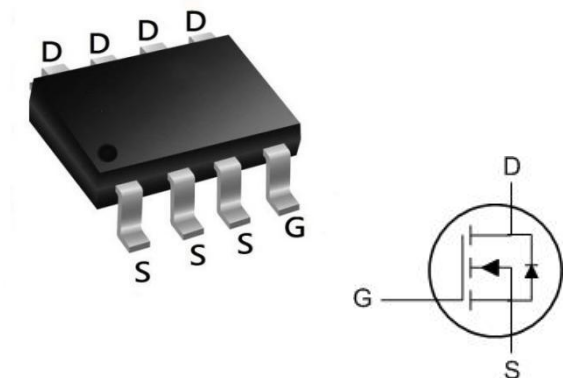
- ★ 100% EAS Guaranteed
- ★ Green Device Available
- ★ Super Low Gate Charge
- ★ Excellent CdV/dt effect decline
- ★ Advanced high cell density Trench technology

**Product Summary**

BVDSS	RDSON	ID
40V	12 mΩ	9A

**Description**

The XXW4009 is the high cell density trenched N-ch MOSFETs, which provide excellent RDSON and gate charge for most of the synchronous buck converter applications. The XXW4009 meet the RoHS and Green Product requirement, 100% EAS guaranteed with full function reliability approved.

**SOP8 Pin Configuration**

**Absolute Maximum Ratings (T<sub>C</sub>=25°C unless otherwise noted)**

Parameter	Symbol	Limit	Unit
Drain-Source Voltage	V <sub>DS</sub>	40	V
Gate-Source Voltage	V <sub>GS</sub>	±20	V
Drain Current-Continuous	I <sub>D</sub>	9	A
Drain Current-Continuous(T <sub>C</sub> =100°C)	I <sub>D</sub> (100°C)	6.4	A
Pulsed Drain Current	I <sub>DM</sub>	40	A
Maximum Power Dissipation	P <sub>D</sub>	2	W
Operating Junction and Storage Temperature Range	T <sub>J</sub> , T <sub>STG</sub>	-55 To 150	°C

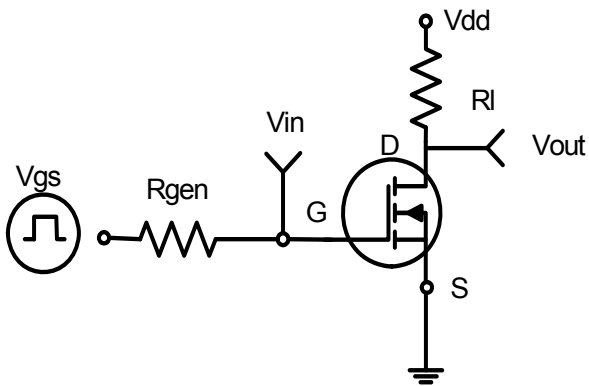
**Thermal Characteristic**

Thermal Resistance, Junction-to-Ambient <sup>(Note 2)</sup>	R <sub>θJA</sub>	62.5	°C/W
---	------------------	------	------

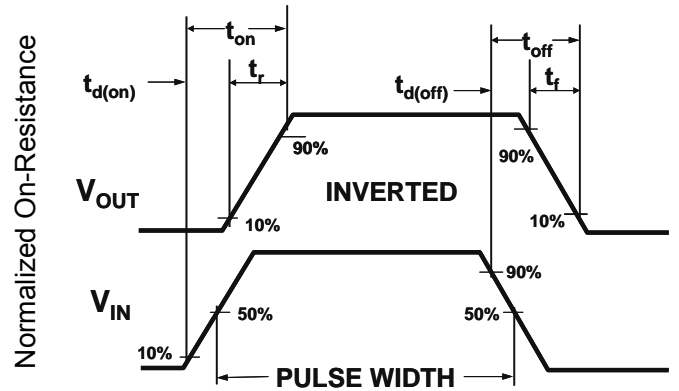
**N-Ch 40V Fast Switching MOSFETs**
**N-CH Electrical Characteristics ( $T_A=25^{\circ}\text{C}$  unless otherwise noted)**

Parameter	Symbol	Condition	Min	Typ	Max	Unit
<b>Off Characteristics</b>						
Drain-Source Breakdown Voltage	$BV_{DSS}$	$V_{GS}=0V, I_D=250\mu A$	40	-	-	V
Zero Gate Voltage Drain Current	$I_{DSS}$	$V_{DS}=40V, V_{GS}=0V$	-	-	1	$\mu A$
Gate-Body Leakage Current	$I_{GSS}$	$V_{GS}=\pm 20V, V_{DS}=0V$	-	-	$\pm 100$	nA
<b>On Characteristics (Note 3)</b>						
Gate Threshold Voltage	$V_{GS(th)}$	$V_{DS}=V_{GS}, I_D=250\mu A$	1	1.5	2.0	V
Drain-Source On-State Resistance	$R_{DS(on)}$	$V_{GS}=10V, I_D=8A$	-	12	16	m $\Omega$
		$V_{GS}=4.5V, I_D=4A$	-	19	24	m $\Omega$
Forward Transconductance	$g_{FS}$	$V_{DS}=5V, I_D=8A$	33	-	-	S
<b>Dynamic Characteristics (Note 4)</b>						
Input Capacitance	$C_{iss}$	$V_{DS}=20V, V_{GS}=0V,$ $F=1.0\text{MHz}$	-	964	-	PF
Output Capacitance	$C_{oss}$		-	109	-	PF
Reverse Transfer Capacitance	$C_{rss}$		-	96	-	PF
<b>Switching Characteristics (Note 4)</b>						
Turn-on Delay Time	$t_{d(on)}$	$V_{DD}=20V, R_L=2.5\Omega$ $V_{GS}=10V, R_{GEN}=3\Omega$	-	5.5	-	nS
Turn-on Rise Time	$t_r$		-	14	-	nS
Turn-Off Delay Time	$t_{d(off)}$		-	24	-	nS
Turn-Off Fall Time	$t_f$		-	12	-	nS
Total Gate Charge	$Q_g$	$V_{DS}=20V, I_D=8A,$ $V_{GS}=10V$	-	22.9	-	nC
Gate-Source Charge	$Q_{gs}$		-	3.5	-	nC
Gate-Drain Charge	$Q_{gd}$		-	5.3	-	nC
<b>Drain-Source Diode Characteristics</b>						
Diode Forward Voltage (Note 3)	$V_{SD}$	$V_{GS}=0V, I_S=9A$	-	0.8	1.2	V

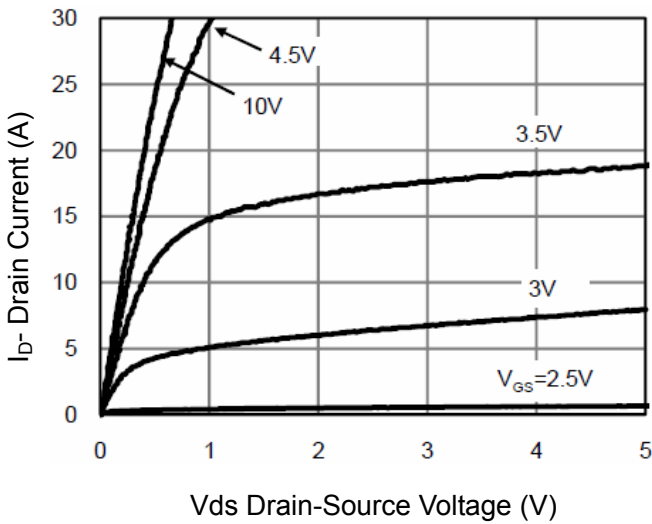
**N- Channel Typical Electrical and Thermal Characteristics (Curves)**



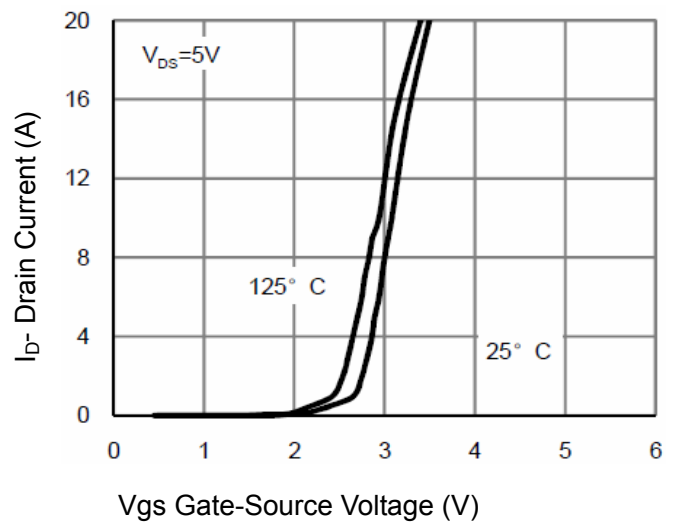
**Figure 1: Switching Test Circuit**



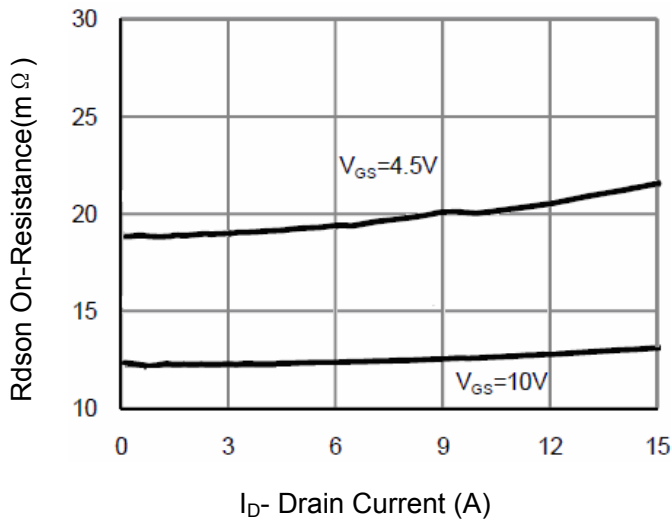
**Figure 2: Switching Waveforms**



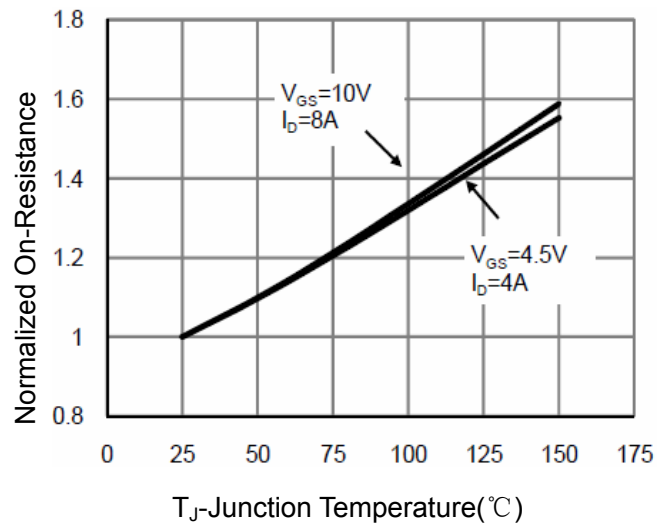
**Figure 3 Output Characteristics**



**Figure 4 Transfer Characteristics**

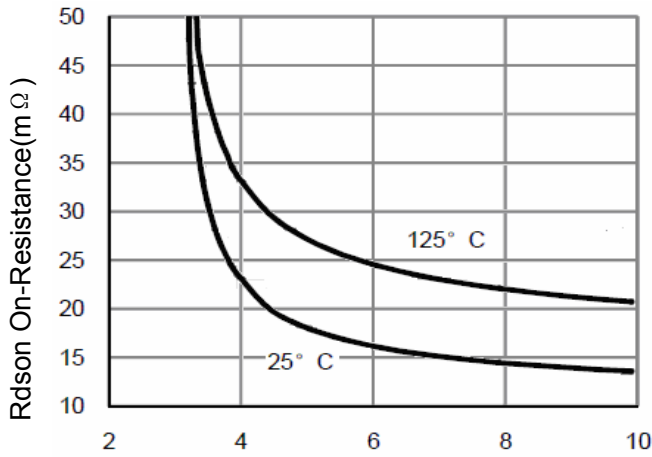


**Figure 5 Drain-Source On-Resistance**

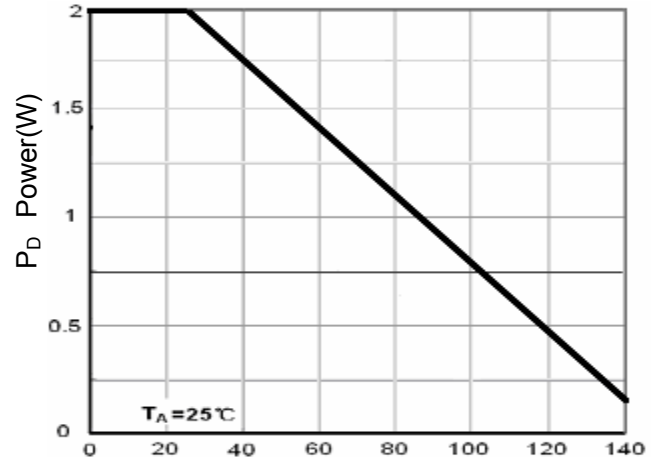


**Figure 6 Drain-Source On-Resistance**

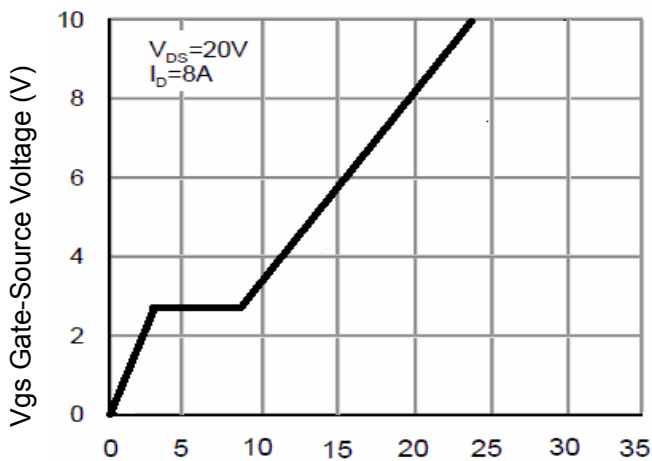
## N-Ch 40V Fast Switching MOSFETs



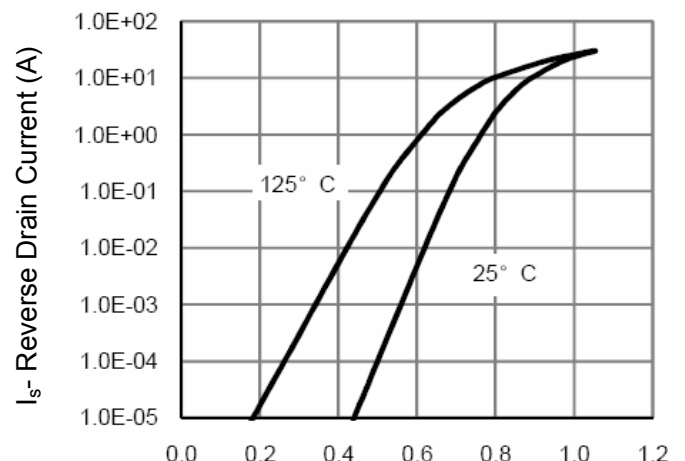
Vgs Gate-Source Voltage (V)  
**Figure 7 Rdson vs Vgs**



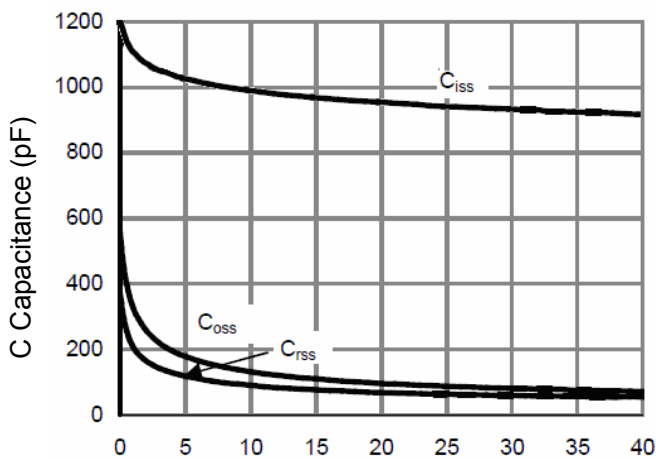
T<sub>J</sub>-Junction Temperature(°C)  
**Figure 8 Power Dissipation**



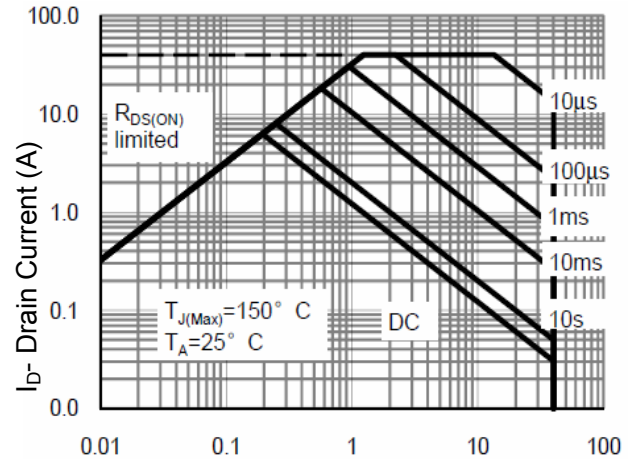
Qg Gate Charge (nC)  
**Figure 9 Gate Charge**



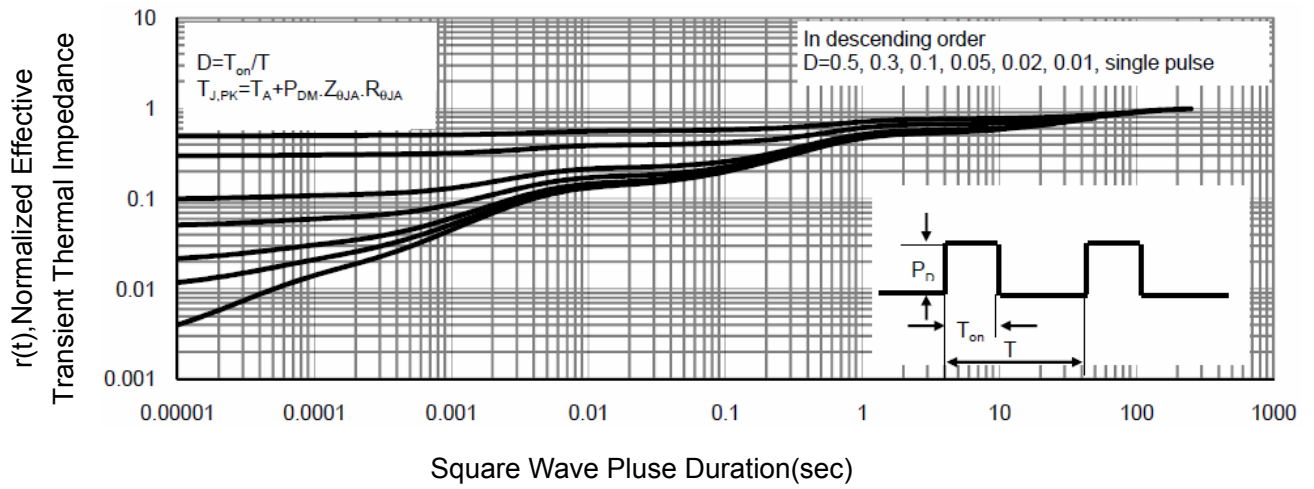
Vds Drain-Source Voltage (V)  
**Figure 10 Source- Drain Diode Forward**



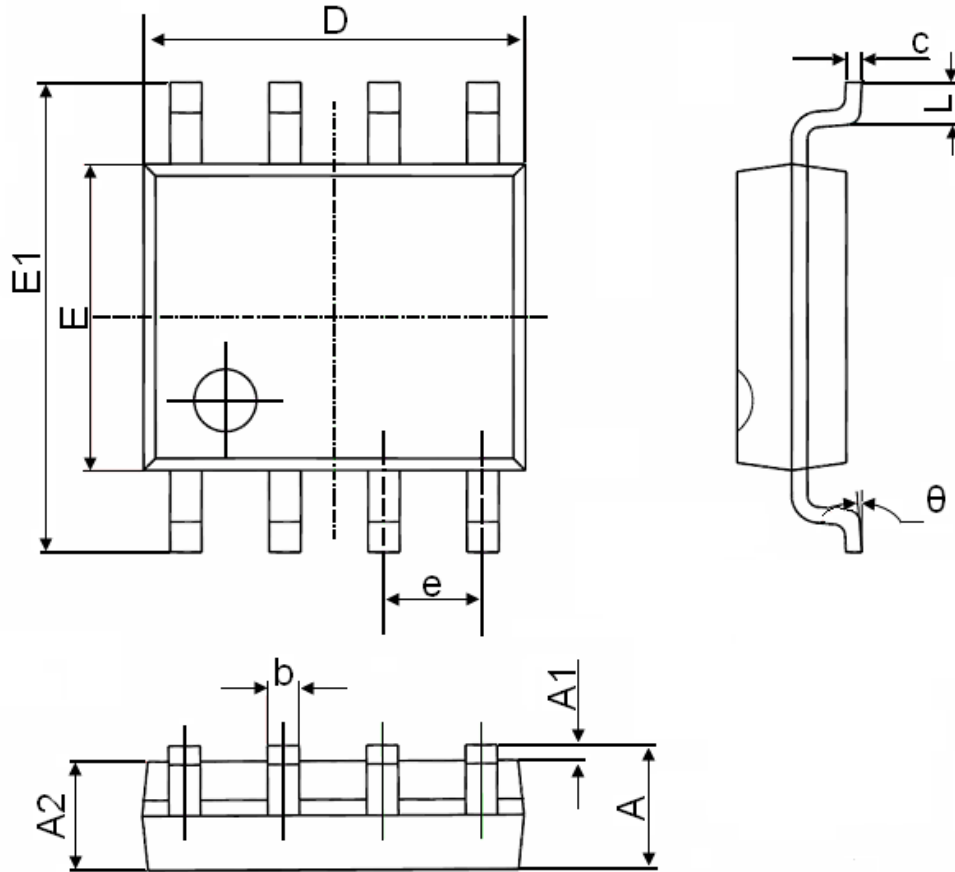
Vds Drain-Source Voltage (V)  
**Figure 11 Capacitance vs Vds**



Vds Drain-Source Voltage (V)  
**Figure 12 Safe Operation Area**



**Figure 13 Normalized Maximum Transient Thermal Impedance**

**SOP-8 Package Information**


Symbol	Dimensions In Millimeters		Dimensions In Inches	
	Min.	Max.	Min.	Max.
A	1.350	1.750	0.053	0.069
A1	0.100	0.250	0.004	0.010
A2	1.350	1.550	0.053	0.061
b	0.330	0.510	0.013	0.020
c	0.170	0.250	0.006	0.010
D	4.700	5.100	0.185	0.200
E	3.800	4.000	0.150	0.157
E1	5.800	6.200	0.228	0.244
e	1.270(BSC)		0.050(BSC)	
L	0.400	1.270	0.016	0.050
$\theta$	0°	8°	0°	8°