

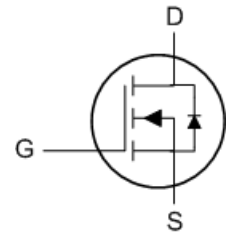
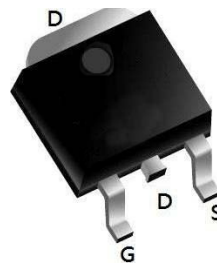
- ★ Green Device Available
- ★ Super Low Gate Charge
- ★ Excellent Cdv/dt effect decline
- ★ Advanced high cell density Trench technology


Product Summary

BVDSS	R _{DS(on)}	I _D
150V	240mΩ	10A

Description

The XXW10N15 is the high cell density trench N-ch MOSFETs, which provides excellent R_{DS(on)} and efficiency for most of the small power switching and load switch applications. The XXW10N15 meet the RoHS and Green Product requirement with full function reliability approved.

TO252 Pin Configuration

5 Vgc`i hY'AU]a i a 'FU]b[g'fH5 '1`&) š7 ži b`Ygg'cH Yfk]gY'bchYXL

Parameter	Symbol	Value	Unit
Drain-Source Voltage	V _{DS}	150	V
Gate-Source Voltage	V _{GS}	±20	V
Continuous Drain Current	I _D	T _C =25°C	10
		T _C =100°C	5.4
Pulsed Drain Current ¹	I _{DM}	35	A
Single Pulse Avalanche Energy ²	E _{AS}	9.8	mJ
Total Power Dissipation	P _D	40.3	W
Operating Junction and Storage Temperature Range	T _J , T _{STG}	-55 to 150	°C

Thermal Characteristics

Parameter	Symbol	Value	Unit
Thermal Resistance from Junction-to-Ambient ³	R _{θJA}	62	°C/W
Thermal Resistance from Junction-to-Case	R _{θJC}	3.1	°C/W

N-Ch 150V Fast Switching MOSFETs
Electrical Characteristics (T_J = 25°C, unless otherwise noted)

Parameter	Symbol	Test Conditions	Min.	Typ.	Max.	Unit	
Static Characteristics							
Drain-Source Breakdown Voltage	V_{(BR)DSS}	V _{GS} = 0V, I _D = 250μA	150	-	-	V	
Gate-body Leakage current	I_{GSS}	V _{DS} = 0V, V _{GS} = ±20V	-	-	±100	nA	
Zero Gate Voltage Drain Current	I_{DSS}	V _{DS} = 150V, V _{GS} = 0V	T _J =25°C	-	-	1	μA
			T _J =100°C	-	-	100	
Gate-Threshold Voltage	V_{GS(th)}	V _{DS} = V _{GS} , I _D = 250μA	1.2	2	2.5	V	
Drain-Source on-Resistance ⁴	R_{DS(on)}	V _{GS} = 10V, I _D = 4A	-	240	300	mΩ	
Forward Transconductance ⁴	g_{fs}	V _{DS} = 10V, I _D = 4A	-	14.5	-	S	
Dynamic Characteristics⁵							
Input Capacitance	C_{iss}	V _{DS} = 75V, V _{GS} = 0V, f = 1MHz	-	465	-	pF	
Output Capacitance	C_{oss}		-	23	-		
Reverse Transfer Capacitance	C_{rss}		-	14	-		
Gate Resistance	R_g	f = 1MHz	-	2	-	Ω	
Switching Characteristics⁵							
Total Gate Charge	Q_g	V _{GS} = 10V, V _{DS} = 75V, I _D = 4A	-	14	-	nC	
Gate-Source Charge	Q_{gs}		-	1.6	-		
Gate-Drain Charge	Q_{gd}		-	4	-		
Turn-on Delay Time	t_{d(on)}	V _{GS} = 10V, V _{DD} = 75V, R _G = 3Ω, I _D = 4A	-	5.8	-	ns	
Rise Time	t_r		-	2.2	-		
Turn-off Delay Time	t_{d(off)}		-	16.9	-		
Fall Time	t_f		-	2.6	-		
Drain-Source Body Diode Characteristics							
Diode Forward Voltage ⁴	V_{SD}	I _S = 1A, V _{GS} = 0V	-	-	1.2	V	
Continuous Source Current	T _C =25°C	I_S	-	-	10	A	

Notes:

1. Repetitive rating, pulse width limited by junction temperature T_{J(MAX)}=150°C.
2. The EAS data shows Max. rating . The test condition is V_{DD}=25V, V_{GS}=10V, L=0.4mH, I_{AS}=7A.
3. The data tested by surface mounted on a 1 inch² FR-4 board with 2OZ copper, The value in any given application depends on the user's specific board design.
4. The data tested by pulsed , pulse width ≤ 300us , duty cycle ≤ 2%.
5. This value is guaranteed by design hence it is not included in the production test.

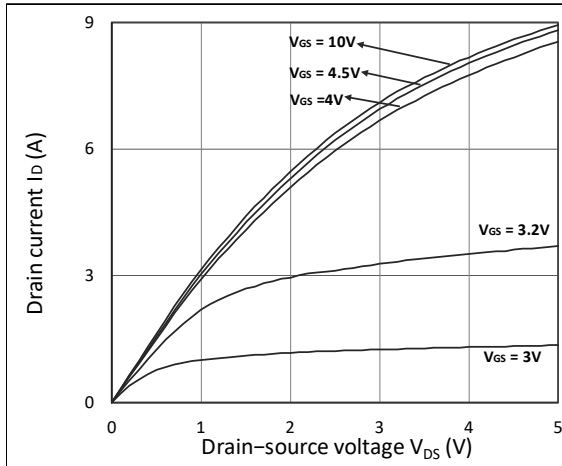
Typical Characteristics


Figure 1. Output Characteristics

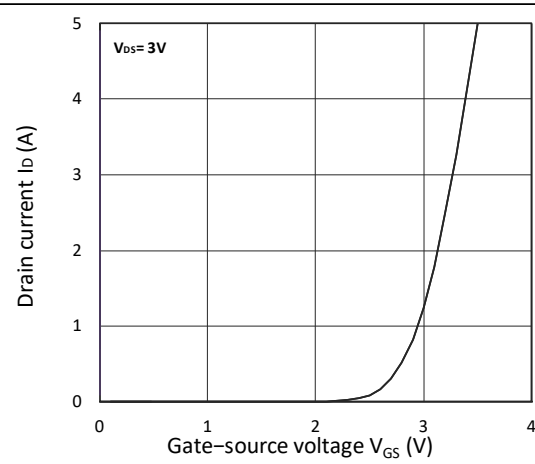


Figure 2. Transfer Characteristics

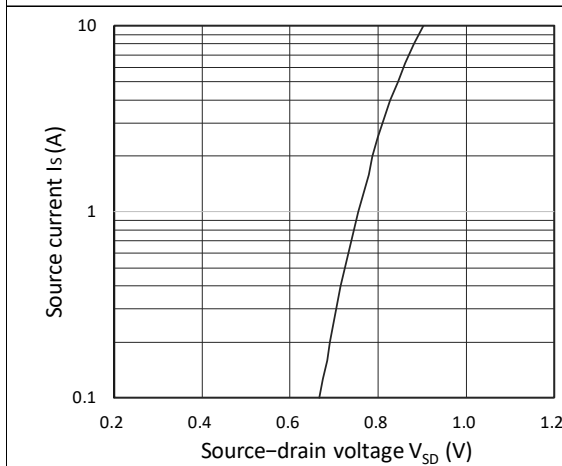
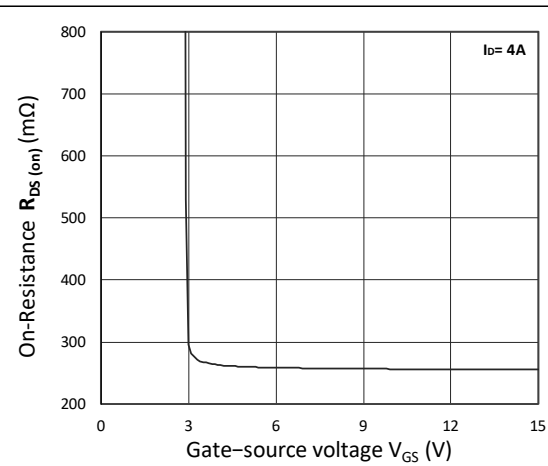
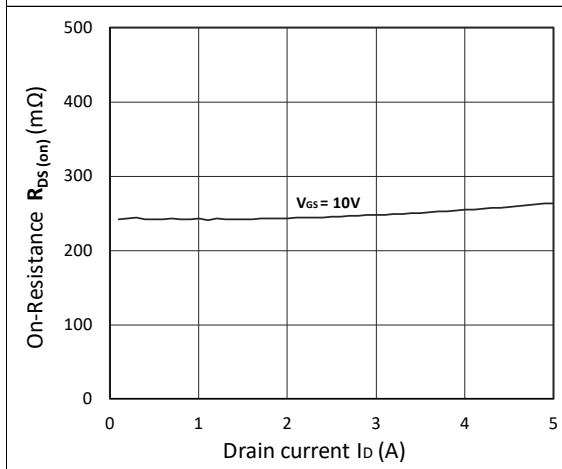
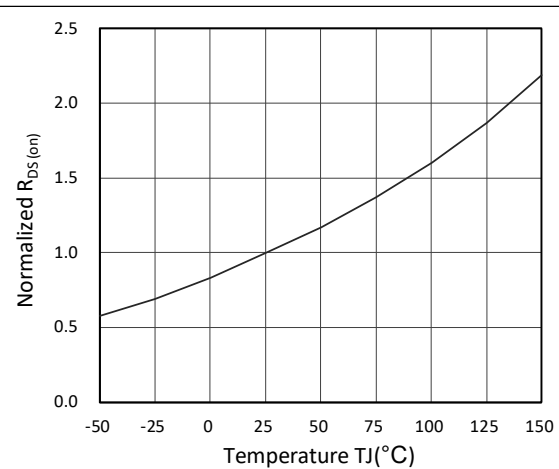


Figure 3. Forward Characteristics of Reverse


 Figure 4. $R_{DS(on)}$ vs. V_{GS}

 Figure 5. $R_{DS(on)}$ vs. I_D

 Figure 6. Normalized $R_{DS(on)}$ vs. Temperature

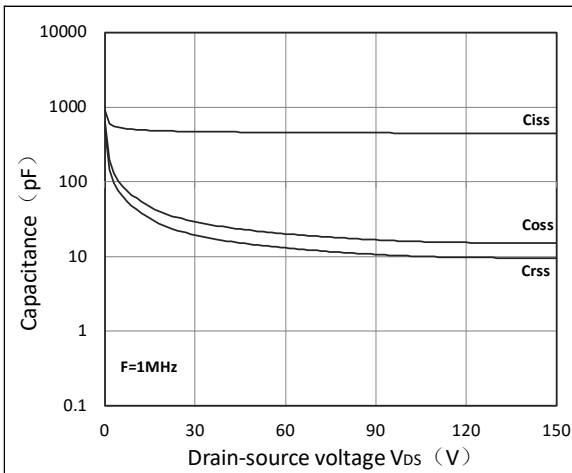
N-Ch 150V Fast Switching MOSFETs


Figure 7. Capacitance Characteristics

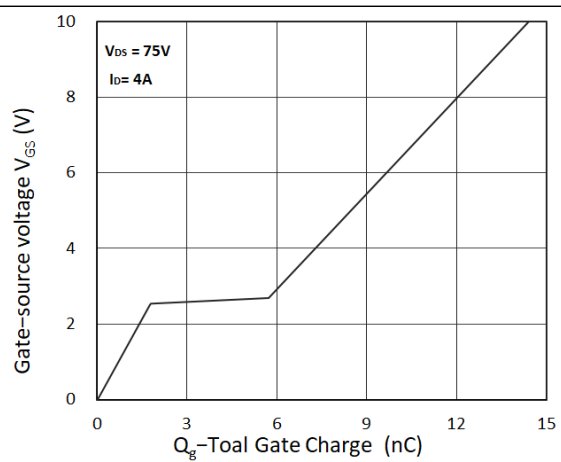


Figure 8. Gate Charge Characteristics

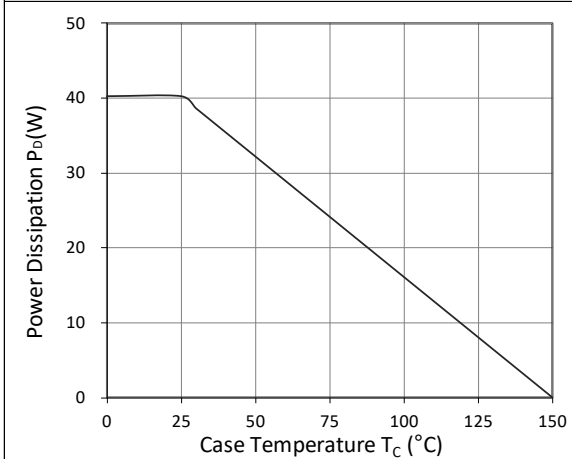


Figure 9. Power Dissipation

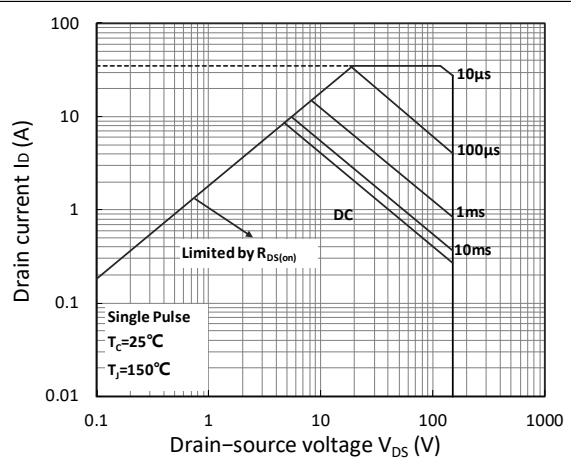


Figure 10. Safe Operating Area

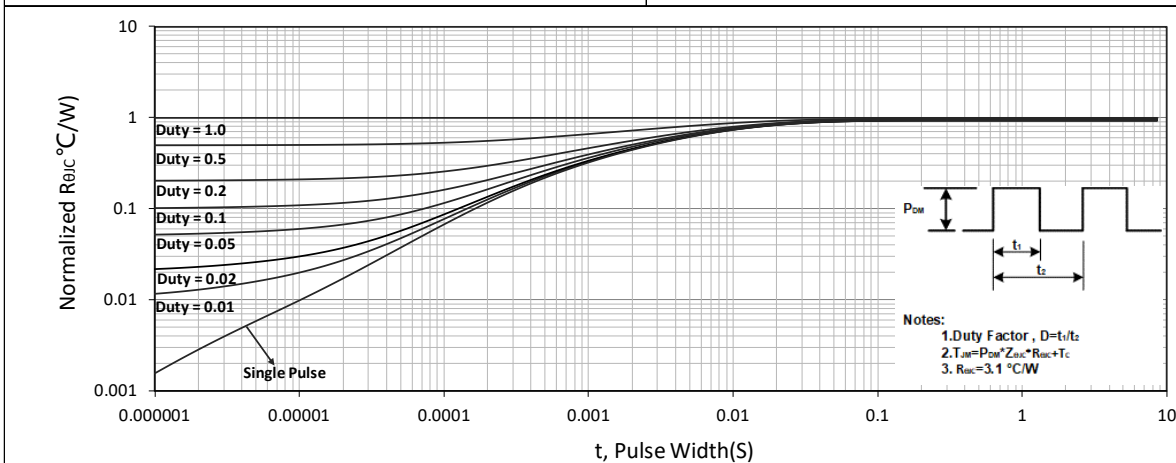
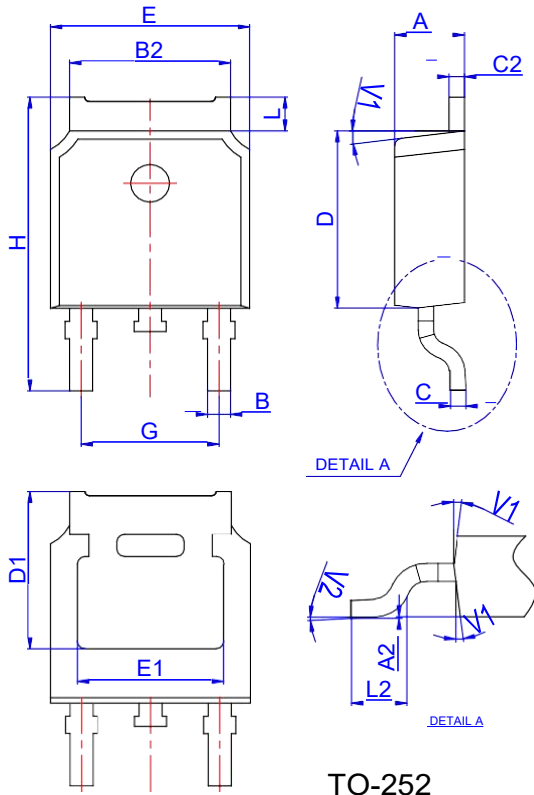
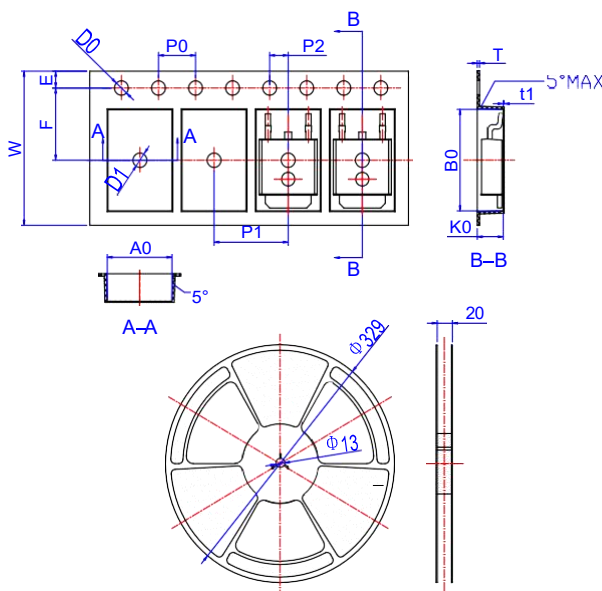


Figure 11. Normalized Maximum Transient Thermal Impedance

Package Mechanical Data-TO-252


Ref.	Dimensions					
	Millimeters			Inches		
	Min.	Typ.	Max.	Min.	Typ.	Max.
A	2.10		2.50	0.083		0.098
A2	0		0.10	0		0.004
B	0.66		0.86	0.026		0.034
B2	5.18		5.48	0.202		0.216
C	0.40		0.60	0.016		0.024
C2	0.44		0.58	0.017		0.023
D	5.90		6.30	0.232		0.248
D1	5.30REF			0.209REF		
E	6.40		6.80	0.252		0.268
E1	4.63			0.182		
G	4.47		4.67	0.176		0.184
H	9.50		10.70	0.374		0.421
L	1.09		1.21	0.043		0.048
L2	1.35		1.65	0.053		0.065
V1		7°			7°	
V2	0°		6°	0°		6°

Reel Specification-TO-252-4R


Ref.	Dimensions					
	Millimeters			Inches		
	Min.	Typ.	Max.	Min.	Typ.	Max.
W	15.90	16.00	16.10	0.626	0.630	0.634
E	1.65	1.75	1.85	0.065	0.069	0.073
F	7.40	7.50	7.60	0.291	0.295	0.299
D0	1.40	1.50	1.60	0.055	0.059	0.063
D1	1.40	1.50	1.60	0.055	0.059	0.063
P0	3.90	4.00	4.10	0.154	0.157	0.161
P1	7.90	8.00	8.10	0.311	0.315	0.319
P2	1.90	2.00	2.10	0.075	0.079	0.083
A0	6.85	6.90	7.00	0.270	0.271	0.276
B0	10.45	10.50	10.60	0.411	0.413	0.417
K0	2.68	2.78	2.88	0.105	0.109	0.113
T	0.24		0.27	0.009		0.011
t1	0.10			0.004		
10P0	39.80	40.00	40.20	1.567	1.575	1.583